

# LINEO DRITTO

## CATENA - CHAIN

### CARATTERISTICHE:

**Tipo di applicazione:** verticale

**Ambiente di applicazione:** interno

**Staffe di fissaggio e mantovana:** in alluminio con finitura satinata, lucida o laccato bianco opaco Ral 9003. Mantovana alta 6 cm completa di tappi terminali. A richiesta gancetti trasparenti reggitenda per l'aggiunta di telo classico decorativo

**Rullo di avvolgimento:** Ø 39 mm o Ø 49 mm (per sistemi comprensivi di molla di compensazione) entrambi in alluminio estruso con ogiva per agevolare la manutenzione del telo

**Fondale:** a scelta squadrato FQ20 in alluminio estruso con tappi in PVC satinati, lucidi o bianchi oppure tondo FL20 in alluminio estruso con tappi in alluminio satinato, lucido o bianco opaco Ral 9003. Finitura fondali: satinato, lucido, bianco opaco Ral 9003

**Manovra:** a catena con comando frizionato Easy Lock in PVC completo di calotta lato opposto con perno rientrante per facilitare lo smontaggio del rullo dalle staffe. Catenella passo 6 con grani Ø 4,5 mm, metallica o bianca in nylon e PVC, dotata di sgancio di sicurezza "child safety device" secondo la norma UNI EN13120:2014

**Fissaggio:** a parete o a soffitto.



### CHARACTERISTICS:

**Application:** vertical

**Installation:** indoor

**Brackets and pelmet:** aluminium satin, polished finish or matt white Ral 9003 powder coated brackets and 6 cm pelmet. Transparent clips for additional decorative curtain on request

**Roller tube:** Ø 39 mm or Ø 49 mm (for blinds with incorporated compensating spring) extruded aluminium tube with slot to facilitate fabric removal

**Hem bar:** FQ20 extruded aluminum square hem bar with PVC end caps (satin, polished, white) or FL20 extruded aluminum round hem bar with aluminium end caps, satin, polished or matt white Ral 9003 powder coated. Hem bar finish: satin, polished and matt white Ral 9003 powder coated

**Operation:** Easy Lock chain operation, opposite side end plug with retractable pin to easily remove the tube from the brackets. Ø 4,5 mm metallic or PVC/nylon bead chain, 6 mm pitch, with incorporated child safety device - UNI EN13120:2014

**Mounting:** wall or ceiling mounting.

### NOTE - NOTES:

I sistemi con rullo Ø 39 mm sono abbinabili a tessuti di peso non superiore a 260 g/m<sup>2</sup>.

The systems with Ø 39 mm roller tube should only be used for fabric weights up to 260 g/m<sup>2</sup>.

I sistemi con rullo Ø 49 mm sono comprensivi della molla di compensazione per agevolare il sollevamento del telo.

The systems with Ø 49 mm have an incorporated compensating spring to facilitate roll up.

Supplemento tinte Ral = + 20% prezzo tabelle finitura satinata.

Ral supplement = satin finish price + 20%

La scelta di abbinare alcuni componenti con finitura differente dallo standard comporta una variazione del prezzo. A choice of different component finishes will result in a price variation.

## SCelta COMPOSIZIONI - CHOICE OF COMPONENTS

### Finiture disponibili - Available finish



alluminio satinato  
satin finish



alluminio lucido  
polished finish



laccato bianco opaco RAL 9003  
matt white RAL 9003

### Fondale - Hem bar



FQ20



FL20

### Varianti tappo fondale FL20 - Hem bar FL20 end caps optional



FL20 standard



FL20 slim

### Supplementi - Supplements

Prolunga per staffa - Bracket extension



satinato - bianco opaco  
satin finish - matt white

€ 19,50 a tenda/blind

lucido - polished finish

€ 26 a tenda/blind

Angolare per mantovana - Pelmet end cap finishing



satinato - bianco opaco  
satin finish - matt white

€ 70 a tenda/blind

lucido - polished finish

€ 98 a tenda/blind

## INGOMBRI - DIMENSIONS

misure in cm - dimensions in cm

### ATTACCO A PARETE - WALL MOUNTING

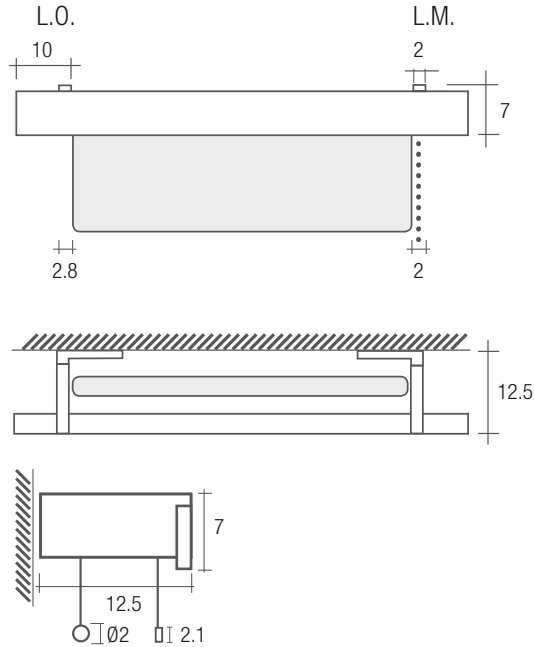

### ATTACCO A SOFFITTO - CEILING MOUNTING

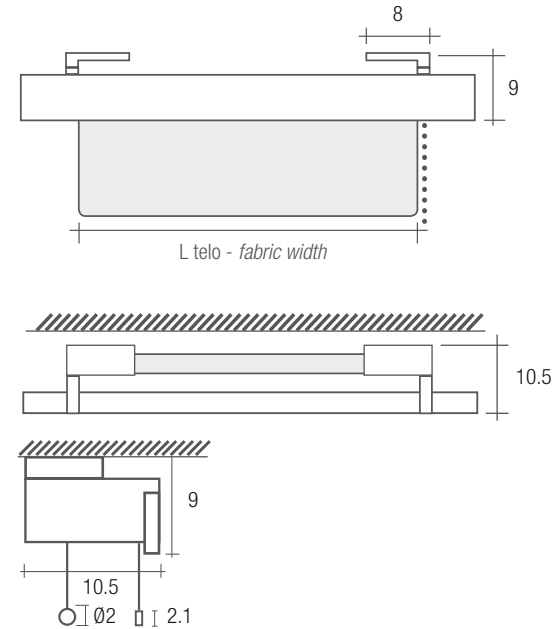

L.M. = lato manovra - operation side  
L.O. = lato opposto - opposite side

# LINEO DRITTO

## MOTORE - MOTOR

### CARATTERISTICHE:

**Tipo di applicazione:** verticale

**Ambiente di applicazione:** interno

**Staffe di fissaggio e mantovana:** in alluminio con finitura satinata, lucida o laccato bianco opaco Ral 9003. Mantovana alta 6 cm completa di tappi terminali. A richiesta gancetti trasparenti reggitenda per l'aggiunta di telo classico decorativo

**Rullo di avvolgimento:** Ø 44 mm (per larghezze fino a 250 cm) o Ø 49 mm (per larghezze fino a 320 cm) entrambi in alluminio estruso con ogiva per agevolare la manutenzione del telo

**Fondale:** a scelta squadrato FQ20 in alluminio estruso con tappi in PVC satinati, lucidi o bianchi oppure tondo FL20 in alluminio estruso con tappi in alluminio satinato, lucido o bianco opaco Ral 9003. Finitura fondali: satinato, lucido, bianco opaco Ral 9003

**Manovra:** a motore tubolare 230V/50Hz, M40, con finecorsa meccanico e cavo di alimentazione. Protezione termica e indice di protezione agli spruzzi d'acqua IP44. Interruttore escluso. A supplemento motore con finecorsa elettronico o motore con ricevente radio integrata

**Fissaggio:** a parete o a soffitto.



## SCelta COMPOSIZIONI - CHOICE OF COMPONENTS

### CHARACTERISTICS:

**Application:** vertical

**Installation:** indoor

**Brackets and pelmet:** aluminium satin, polished finish or matt white Ral 9003 powder coated brackets and 6 cm pelmet. Transparent clips for additional decorative curtain on request

**Roller tube:** Ø 44 mm (up to width 250 cm) or Ø 49 mm (up to width 320 cm) extruded aluminium tube with slot to facilitate fabric removal

**Hem bar:** FQ20 extruded aluminum square hem bar with PVC end caps (satin, polished, white) or FL20 extruded aluminum round hem bar with aluminium end caps, satin, polished or matt white Ral 9003 powder coated. Hem bar finish: satin, polished and matt white Ral 9003 powder coated

**Operation:** M40 230V/50Hz tubular motor with top/bottom limit switches and mains cable, thermal cut-out and class IP44 water resistance. Switch excluded. Supplement for motor with electronic limit switch or for motor with incorporated receiver

**Mounting:** wall or ceiling mounting.

### Finiture disponibili - Available finish



alluminio satinato  
satin finish



alluminio lucido  
polished finish



laccato bianco opaco RAL 9003  
matt white RAL 9003

### Fondale - Hem bar



FQ20



FL20

### Varianti tappo fondale FL20 - Hem bar FL20 end caps optional



FL20 standard



FL20 slim

### Supplementi - Supplements

Prolunga per staffa - Bracket extension



satinato - bianco opaco  
satin finish - matt white

€ 19,50 a tenda/blind

lucido - polished finish

€ 26 a tenda/blind

Angolare per mantovana - Pelmet end cap finishing



satinato - bianco opaco  
satin finish - matt white

€ 70 a tenda/blind

lucido - polished finish

€ 98 a tenda/blind

### NOTE - NOTES:

Supplemento tinte Ral = + 20% prezzo tabella finitura satinata.  
Ral supplement = satin finish price + 20%

La scelta di abbinare alcuni componenti con finitura differente dallo standard comporta una variazione del prezzo. A choice of different component finishes will result in a price variation.

### Supplementi - Supplements

■ motore con finecorsa elettronico  
motor with electronic switch

€ 96

■ motore con ricevente radio integrata  
motor with incorporated receiver

€ 152

■ telecomando monocanale  
remote control single channel

€ 96

■ telecomando multicanale (5 canali + 1 generale)  
remote control (5 channels + 1 general)

€ 124

## INGOMBRI - DIMENSIONS

misure in cm - dimensions in cm

### ATTACCO A PARETE - WALL MOUNTING

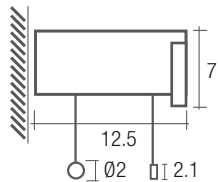
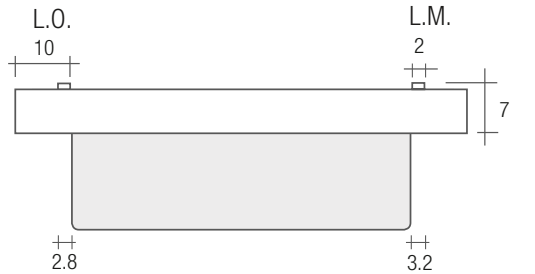

L.M. = lato manovra - operation side  
L.O. = lato opposto - opposite side

### ATTACCO A SOFFITTO - CEILING MOUNTING

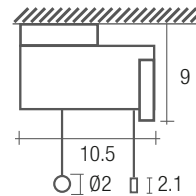
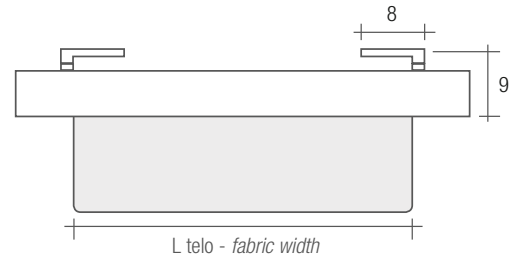



# INGOMBRI - DIMENSIONS

misure in cm - dimensions in cm

## ATTACCO A PARETE - WALL MOUNTING

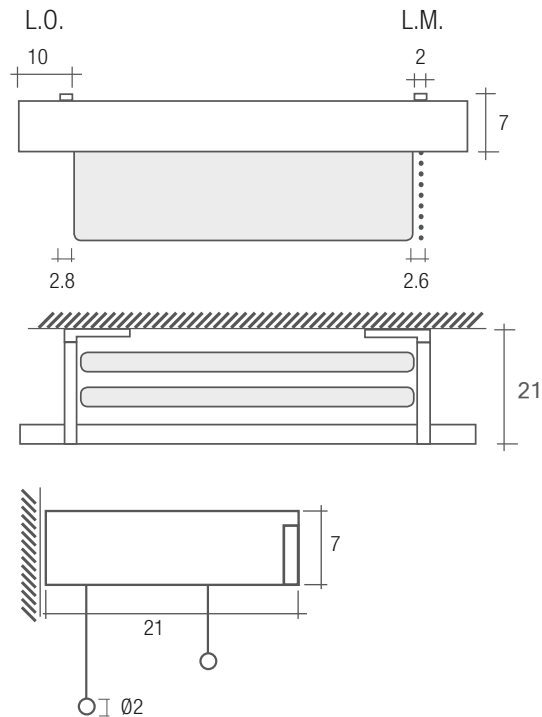

L.M. = lato motore - operation side L.O. = lato opposto - opposite side

## ATTACCO A SOFFITTO - CEILING MOUNTING

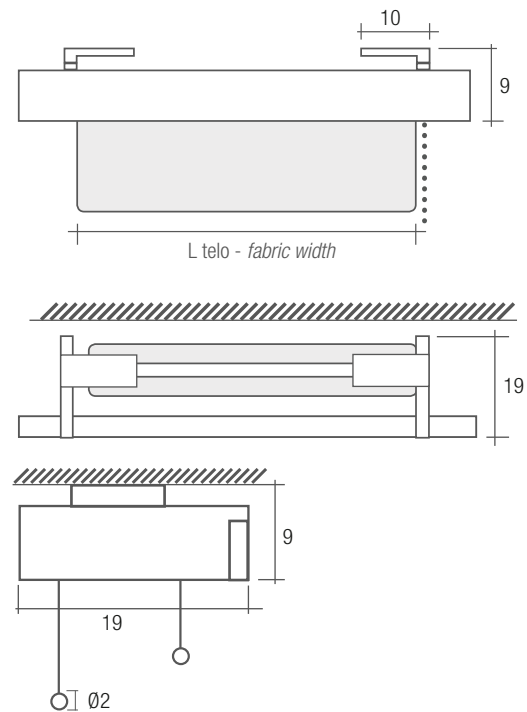

# LINEO DRITTO

## doppio rullo - *double tube*

MOTORE - *MOTOR*

### CARATTERISTICHE:

**Tipo di applicazione:** verticale

**Ambiente di applicazione:** interno

**Staffe di fissaggio e mantovana:** supporti portarullo doppi in alluminio satinato, lucido o laccato bianco opaco Ral 9003. Mantovana alta 6 cm completa di tappi terminali. A richiesta gancetti trasparenti reggitemda per l'aggiunta di telo classico decorativo

**Doppio rullo di avvolgimento:** Ø 44 mm (per larghezze fino a 250 cm) o Ø 49 mm (per larghezze fino a 320 cm) entrambi in alluminio estruso con ogiva per agevolare la manutenzione del telo

**Fondale:** a scelta squadrato FQ20 in alluminio estruso con tappi in PVC satinati, lucidi o bianchi oppure tondo FL20 in alluminio estruso con tappi in alluminio satinato, lucido o bianco opaco Ral 9003. Finitura fondali: satinato, lucido, bianco opaco Ral 9003

**Manovra:** a motore tubolare 230V/50Hz, M40, con finecorsa meccanico e cavo di alimentazione. Protezione termica e indice di protezione agli spruzzi d'acqua IP44. Interruttore escluso. A supplemento motore con finecorsa elettronico o motore con ricevente radio integrata

**Fissaggio:** a parete o a soffitto.

### CHARACTERISTICS:

**Application:** vertical

**Installation:** indoor

**Brackets and pelmet:** double tube side brackets and 6 cm pelmet in aluminium satin finish, polished finish or matt white Ral 9003 powder coated. Transparent clips for additional decorative curtain on request

**Double roller tube:** Ø 44 mm (up to width 250 cm) or Ø 49 mm (up to width 320 cm) extruded aluminium tube with slot to facilitate fabric removal

**Hem bar:** FQ20 extruded aluminum square hem bar with PVC end caps (satin, polished, white) or FL20 extruded aluminum round hem bar with aluminium end caps, satin, polished or matt white Ral 9003 powder coated. Hem bar finish: satin, polished and matt white Ral 9003 powder coated

**Operation:** M40 230V/50Hz tubular motor with top/bottom limit switches and mains cable, thermal cut-out and class IP44 water resistance. Switch excluded. Supplement for motor with electronic limit switch or for motor with incorporated receiver.

**Mounting:** wall or ceiling mounting.

### NOTE - NOTES:

Supplemento tinte Ral = + 20% prezzo tabelle finitura satinata.  
Ral supplement = satin finish price + 20%

La scelta di abbinare alcuni componenti con finitura differente dallo standard comporta una variazione del prezzo. A choice of different component finishes will result in a price variation.



### SCelta COMPOSIZIONI - CHOICE OF COMPONENTS

#### Finiture disponibili - Available finish



alluminio satinato  
satin finish



alluminio lucido  
polished finish



laccato bianco opaco RAL 9003  
matt white RAL 9003

#### Fondale - Hem bar



FQ20



FL20



FQ20 standard

FL20 slim

#### Varianti tappo fondale FL20 - Hem bar FL20 end caps optional

#### Supplementi - Supplements

Prolunga per staffa - Bracket extension



satinato - bianco opaco  
satin finish - matt white

lucido - polished finish

Angolare per mantovana - Pelmet end cap finishing



satinato - bianco opaco  
satin finish - matt white

lucido - polished finish

#### Supplementi - Supplements

■ motore con finecorsa elettronico  
motor with electronic switch

■ telecomando monocanale  
remote control single channel

■ motore con ricevente radio integrata  
motor with incorporated receiver

■ telecomando multicanale (5 canali + 1 generale)  
remote control (5 channels + 1 general)

# INGOMBRI - DIMENSIONS

misure in cm - dimensions in cm

l a y l i g h t<sup>®</sup>

## ATTACCO A PARETE - WALL MOUNTING

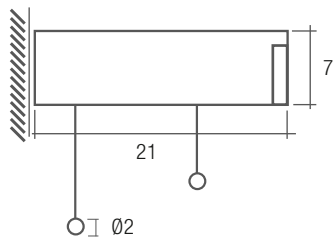
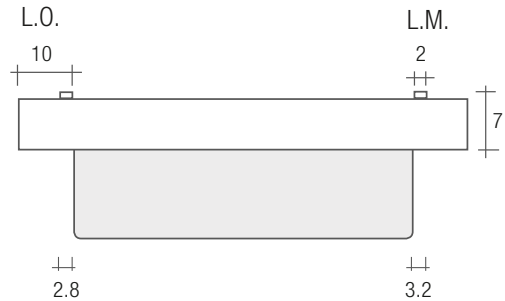

## ATTACCO A SOFFITTO - CEILING MOUNTING

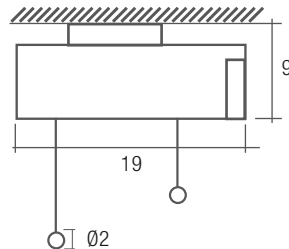
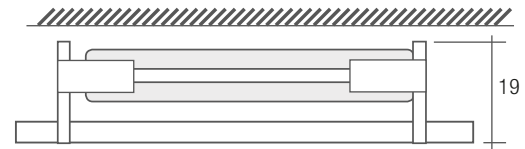
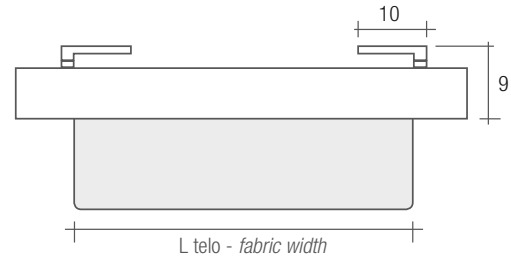

L.M. = lato motore - operation side L.O. = lato opposto - opposite side



# LINEO DRITTO

doppio modulo - *double module*

CATENA - *CHAIN*

## CARATTERISTICHE:

**Tipo di applicazione:** verticale

**Ambiente di applicazione:** interno

**Staffe di fissaggio e mantovana:** in alluminio con finitura satinata, lucida o laccato bianco opaco Ral 9003

Mantovana alta 6 cm completa di tappi terminali. A richiesta gancetti trasparenti reggitenda per l'aggiunta di telo classico decorativo. Presenza di supporto intermedio

**Rullo di avvolgimento:** Ø 39 mm o Ø 49 mm (per sistemi comprensivi di molla di compensazione) entrambi in alluminio estruso con ogiva per agevolare la manutenzione del telo

**Fondale:** a scelta squadrato FQ20 in alluminio estruso con tappi in PVC satinati, lucidi o bianchi oppure tondo FL20 in alluminio estruso con tappi in alluminio satinato, lucido o bianco opaco Ral 9003. Finitura fondali: satinato, lucido, bianco opaco Ral 9003

**Manovra:** a catena con comando frizionato Easy Lock in PVC. Catenella passo 6 con grani Ø 4,5 mm, metallica o bianca in nylon e PVC, dotata di sgancio di sicurezza "child safety device" secondo la norma UNI EN13120:2014.

**Fissaggio:** a parete o a soffitto.

## CHARACTERISTICS:

**Application:** vertical

**Installation:** indoor

**Brackets and pelmet:** aluminium satin, polished finish or matt white Ral 9003 powder coated brackets and 6 cm pelmet. Transparent clips for additional decorative curtain on request. Intermediate bracket for double module

**Roller tube:** Ø 39 mm or Ø 49 mm (for blinds with incorporated compensating spring) extruded aluminium tube with slot to facilitate fabric removal

**Hem bar:** FQ20 extruded aluminium square hem bar with PVC end caps (satin, polished, white) or FL20 extruded aluminium round hem bar with aluminium end caps, satin, polished or matt white Ral 9003 powder coated. Hem bar finish: satin, polished and matt white Ral 9003 powder coated

**Operation:** Easy Lock chain operation Ø 4,5 mm metallic or PVC/nylon bead chain, 6 mm pitch, with incorporated child safety device - UNI EN13120:2014

**Mounting:** wall or ceiling mounting.

## NOTE - NOTES:

I sistemi con rullo Ø 39 mm sono abbinabili a tessuti di peso non superiore a 260 g/m<sup>2</sup>.

The systems with Ø 39 mm roller tube should only be used for fabric weights up to 260 g/m<sup>2</sup>.

I sistemi con rullo Ø 49 mm sono comprensivi della molla di compensazione per agevolare il sollevamento del telo.

The systems with Ø 49 mm have an incorporated compensating spring to facilitate roll up.

Supplemento tinte Ral = + 20% prezzo tabelle finitura satinata.

Ral supplement = satin finish price + 20%

La scelta di abbinare alcuni componenti con finitura differente dallo standard comporta una variazione del prezzo. A choice of different component finishes will result in a price variation.



supporto intermedio  
intermediate bracket



## SCelta Composizioni - CHOICE OF COMPONENTS

### Finiture disponibili - Available finish



alluminio satinato  
satin finish



alluminio lucido  
polished finish



laccato bianco opaco RAL 9003  
matt white RAL 9003

### Fondale - Hem bar



FQ20



FL20

### Varianti tappo fondale FL20 - Hem bar FL20 end caps optional



FQ20 standard



FL20 slim

### Supplementi - Supplements

Prolunga per staffa - Bracket extension



satinato - bianco opaco  
satin finish - matt white

lucido - polished finish

Angolare per mantovana - Pelmet end cap finishing



satinato - bianco opaco  
satin finish - matt white

lucido - polished finish

# INGOMBRI - DIMENSIONS

misure in cm - dimensions in cm

## ATTACCO A PARETE - WALL MOUNTING

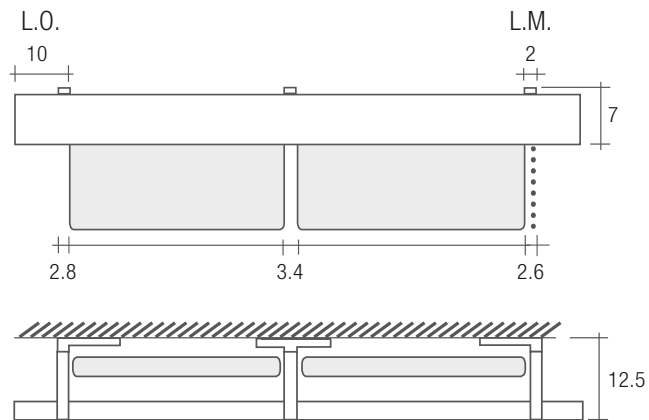

## ATTACCO A SOFFITTO - CEILING MOUNTING

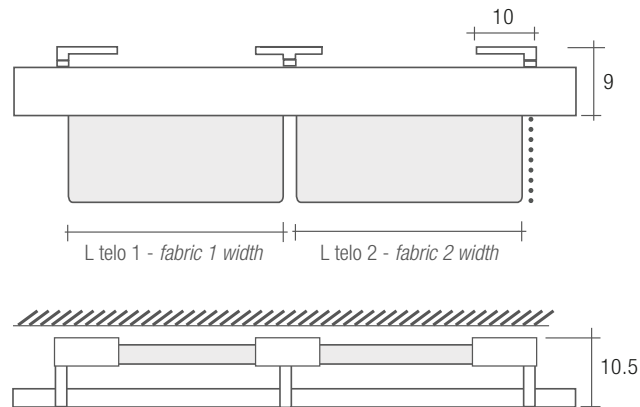

supporti intermedi - intermediate brackets

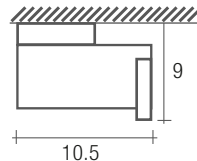
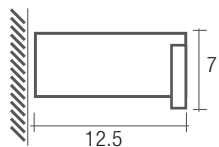

L.M. = lato motore - operation side L.O. = lato opposto - opposite side

# LINEO DRITTO

doppio modulo - *double module*

MOTORE - *MOTOR*

CARATTERISTICHE:

**Tipo di applicazione:** verticale

**Ambiente di applicazione:** interno

**Staffe di fissaggio e mantovana:** in alluminio con finitura satinata, lucida o laccato bianco opaco Ral 9016. Mantovana alta 6 cm completa di tappi terminali. A richiesta gancetti trasparenti reggitenda per l'aggiunta di telo classico decorativo. Presenza di supporto intermedio

**Rullo di avvolgimento:** Ø 44 mm o Ø 49 mm entrambi in alluminio estruso con ogiva per agevolare la manutenzione del telo

**Fondale:** a scelta squadrato FQ20 in alluminio estruso con tappi in PVC satinati, lucidi o bianchi oppure tondo FL20 in alluminio estruso con tappi in alluminio satinato, lucido o bianco opaco Ral 9016. Finitura fondali: satinato, lucido, bianco opaco Ral 9003

**Manovra:** a motore tubolare 230V/50Hz, M40, con finecorsa meccanico e cavo di alimentazione. Protezione termica e indice di protezione agli spruzzi d'acqua IP44. Interruttore escluso. A supplemento motore con finecorsa elettronico o motore con ricevente radio integrata

**Fissaggio:** a parete o a soffitto.



supporto intermedio  
*intermediate bracket*



## CHARACTERISTICS:

**Application:** vertical

**Installation:** indoor

**Brackets and pelmet:** aluminium satin, polished finish or matt white Ral 9016 powder coated brackets and 6 cm pelmet. Transparent clips for additional decorative curtain on request. Intermediate bracket for double module

**Roller tube:** Ø 44 mm or Ø 49 mm extruded aluminium tube with slot to facilitate fabric removal

**Hem bar:** FQ20 extruded aluminum square hem bar with PVC end caps (satin, polished, white) or FL20 extruded aluminum round hem bar with aluminium end caps, satin, polished or matt white Ral 9016 powder coated. Hem bar finish: satin, polished and matt white Ral 9003 powder coated

**Operation:** M40 230V/50Hz tubular motor with top/bottom limit switches and mains cable, thermal cut-out and class IP44 water resistance. Switch excluded. Supplement for motor with electronic limit switch or for motor with incorporated receiver

**Mounting:** wall or ceiling mounting.

## SCelta Composizioni - CHOICE OF COMPONENTS

### Finiture disponibili - Available finish



alluminio satinato  
*satin finish*



alluminio lucido  
*polished finish*



laccato bianco opaco RAL 9003  
*matt white RAL 9003*

### Fondale - Hem bar



FQ20



FL20



FQ20 standard



FL20 slim

### Varianti tappo fondale FL20 - Hem bar FL20 end caps optional

### Supplementi - Supplements

Prolunga per staffa - *Bracket extension*



satinato - bianco opaco  
*satin finish - matt white*

lucido - *polished finish*

Angolare per mantovana - *Pelmet end cap finishing*



satinato - bianco opaco  
*satin finish - matt white*

lucido - *polished finish*

## NOTE - NOTES:

Supplemento tinte Ral = + 20% prezzo tabelle finitura satinata.  
*Ral supplement = satin finish price + 20%*

La scelta di abbinare alcuni componenti con finitura differente dallo standard comporta una variazione del prezzo. *A choice of different component finishes will result in a price variation.*

### Supplementi - Supplements

■ motore con finecorsa elettronico  
*motor with electronic switch*

■ telecomando monocanale  
*remote control single channel*

■ motore con ricevente radio integrata  
*motor with incorporated receiver*

■ telecomando multicanale (5 canali + 1 generale)  
*remote control (5 channels + 1 general)*

# INGOMBRI - DIMENSIONS

misure in cm - dimensions in cm

## ATTACCO A PARETE - WALL MOUNTING

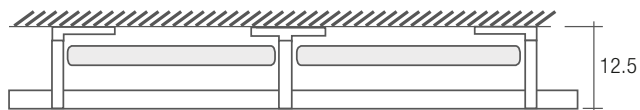
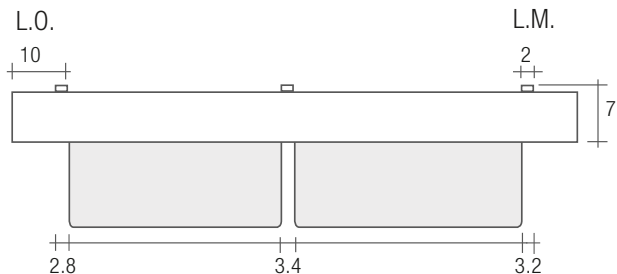

supporti intermedi - intermediate brackets

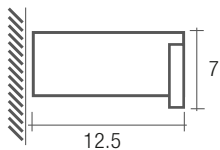

## ATTACCO A SOFFITTO - CEILING MOUNTING

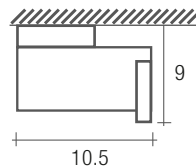
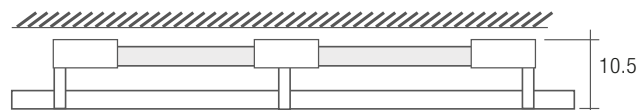
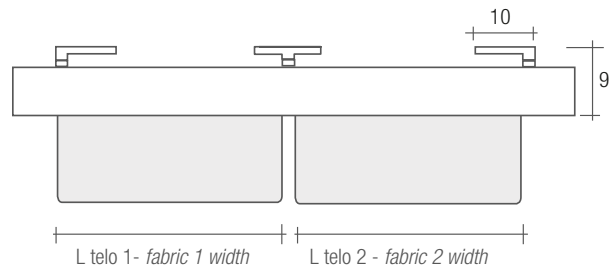

L.M. = lato motore - operation side L.O. = lato opposto - opposite side

# LINEO DRITTO

doppio modulo con doppio rullo  
e sormonto  
*double module with double tube  
and overlapping fabrics*

## CATENA - CHAIN

### CARATTERISTICHE:

**Tipo di applicazione:** verticale

**Ambiente di applicazione:** interno

**Staffe di fissaggio e mantovana:** supporti portarullo doppi in alluminio satinato, lucido o laccato bianco opaco Ral 9003. Mantovana alta 6 cm completa di tappi terminali. A richiesta gancetti trasparenti reggitingola per l'aggiunta di telo classico decorativo. Presenza di supporto intermedio

**Doppio rullo di avvolgimento:** Ø 39 mm o Ø 49 mm (per sistemi comprensivi di molla di compensazione) entrambi in alluminio estruso con ogiva

**Fondali:** a scelta squadrato FQ20 in alluminio estruso con tappi in PVC satinati, lucidi o bianchi oppure tondo FL20 in alluminio estruso con tappi in alluminio satinato, lucido o bianco opaco Ral 9003. Finitura fondali: satinato, lucido, bianco opaco Ral 9003

**Manovra:** a catena con comando frizionato Easy Lock in PVC. Catenella passo 6 con grani Ø 4,5 mm, metallica o bianca in nylon e PVC, dotata di sgancio di sicurezza "child safety device" secondo la norma UNI EN13120:2014

**Fissaggio:** a parete o a soffitto.

### CHARACTERISTICS:

**Application:** vertical

**Installation:** indoor

**Brackets and pelmet:** double tube side brackets and 6 cm pelmet in aluminium satin finish, polished finish or matt white Ral 9003 powder coated. Transparent clips for additional decorative curtain on request. Intermediate bracket

**Double roller tube:** Ø 39 mm or Ø 49 mm (for blinds with incorporated compensating spring) extruded aluminium tube with slot to facilitate fabric removal

**Hem bar:** FQ20 extruded aluminium square hem bar with PVC end caps (satin, polished, white) or FL20 extruded aluminium round hem bar with aluminium end caps, satin, polished or matt white Ral 9003 powder coated. Hem bar finish: satin, polished and matt white Ral 9003 powder coated

**Operation:** Easy Lock chain operation Ø 4,5 mm metallic or PVC/nylon bead chain, 6 mm pitch, with incorporated child safety device - UNI EN13120:2014

**Mounting:** wall or ceiling mounting.

### NOTE - NOTES:

I sistemi con rullo Ø 39 mm sono abbinabili a tessuti di peso non superiore a 260 g/m<sup>2</sup>.

*The systems with Ø 39 mm roller tube should only be used for fabric weights up to 260 g/m<sup>2</sup>.*

I sistemi con rullo Ø 49 mm sono comprensivi della molla di compensazione per agevolare il sollevamento del telo.

*The systems with Ø 49 mm roller tube have an incorporated compensating spring to facilitate roll up.*

Supplemento tinte Ral = + 20% prezzo tabella finitura satinata.  
*Ral supplement = satin finish price + 20%*

La scelta di abbinare alcuni componenti con finitura differente dallo standard comporta una variazione del prezzo. *A choice of different component finishes will result in a price variation.*



supporto intermedio  
*intermediate bracket*



### SCELTA COMPOSIZIONI - CHOICE OF COMPONENTS

#### Finiture disponibili - Available finish



alluminio satinato  
*satin finish*



alluminio lucido  
*polished finish*



laccato bianco opaco RAL 9003  
*matt white RAL 9003*

#### Fondale - Hem bar



FQ20



FL20

#### Varianti tappo fondale FL20 - Hem bar FL20 end caps optional



FL20 standard



FL20 slim

#### Supplementi - Supplements

Prolunga per staffa - Bracket extension



satinato - bianco opaco  
*satin finish - matt white*

lucido - polished finish

Angolare per mantovana - Pelmet end cap finishing



satinato - bianco opaco  
*satin finish - matt white*

lucido - polished finish

## INGOMBRI - DIMENSIONS

### ATTACCO A PARETE - WALL MOUNTING

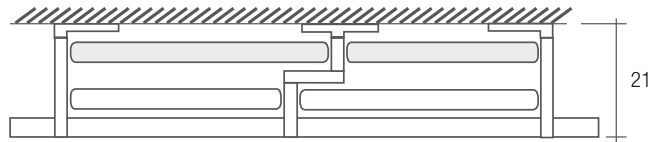
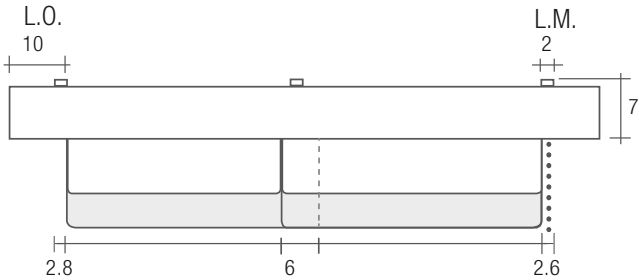

supporti intermedi - intermediate brackets

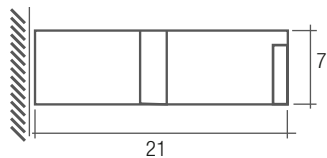

L.M. = lato motore - operation side L.O. = lato opposto - opposite side

### ATTACCO A SOFFITTO - CEILING MOUNTING

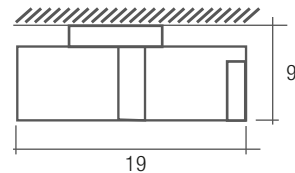
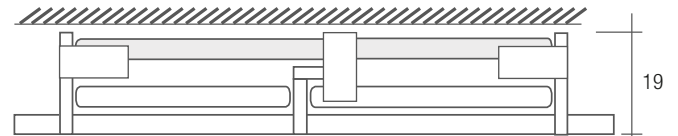
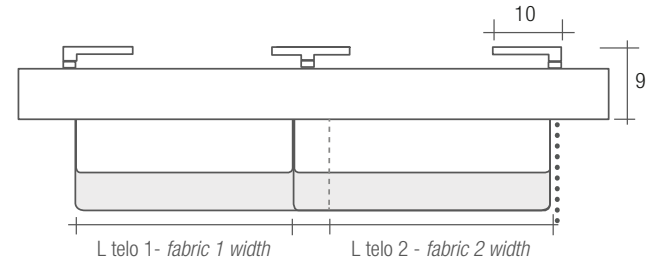

# LINEO DRITTO

doppio modulo con doppio rullo e sormonto  
*double module with double tube and overlapping fabrics*

MOTORE - MOTOR

CARATTERISTICHE:

**Tipo di applicazione:** verticale

**Ambiente di applicazione:** interno

**Staffe di fissaggio e mantovana:** supporti portarullo doppi in alluminio satinato, lucido o laccato bianco opaco Ral 9003. Mantovana alta 6 cm completa di tappi terminali. A richiesta gancetti trasparenti reggitenda per l'aggiunta di telo classico decorativo. Presenza di supporto intermedio

**Doppio rullo di avvolgimento:** Ø 44 mm o Ø 49 mm entrambi in alluminio estruso con ogiva

**Fondali:** a scelta squadrato FQ20 in alluminio estruso con tappi in PVC satinati, lucidi o bianchi oppure tondo FL20 in alluminio estruso con tappi in alluminio satinato, lucido o bianco opaco Ral 9003. Finitura fondali: satinato, lucido, bianco opaco Ral 9003

**Manovra:** a motore tubolare 230V/50Hz, M40, con finecorsa meccanico e cavo di alimentazione. Protezione termica e indice di protezione agli spruzzi d'acqua IP44. Interruttore escluso. A supplemento motore con finecorsa elettronico o motore con ricevente radio integrata

**Fissaggio:** a parete o a soffitto.

## CHARACTERISTICS:

**Application:** vertical

**Installation:** indoor

**Brackets and pelmet:** double tube side brackets and 6 cm pelmet in aluminium satin finish, polished finish or matt white Ral 9003 powder coated. Transparent clips for additional decorative curtain on request. Intermediate bracket

**Double roller tube:** Ø 44 mm o Ø 49 mm extruded aluminium tube with slot to facilitate fabric removal

**Hem bar:** FQ20 extruded aluminum square hem bar with PVC end caps (satin, polished, white) or FL20 extruded aluminum round hem bar with aluminium end caps, satin, polished or matt white Ral 9003 powder coated. Hem bar finish: satin, polished and matt white Ral 9003 powder coated

**Operation:** M40 230V/50Hz tubular motor with top/bottom limit switches and mains cable, thermal cut-out and class IP44 water resistance. Switch excluded. Supplement for motor with electronic limit switch or for motor with incorporated receiver

**Mounting:** wall or ceiling mounting.

## NOTE - NOTES:

I sistemi con rullo Ø 39 mm sono abbinabili a tessuti di peso non superiore a 260 g/m<sup>2</sup>.  
*The systems with Ø 39 mm roller tube should only be used for fabric weights up to 260 g/m<sup>2</sup>.*

I sistemi con rullo Ø 49 mm sono comprensivi della molla di compensazione per agevolare il sollevamento del telo.  
*The systems with Ø 49 mm roller tube have an incorporated compensating spring to facilitate roll up.*

Supplemento tinte Ral = + 20% prezzo tabelle finitura satinata.  
*Ral supplement = satin finish price + 20%*

La scelta di abbinare alcuni componenti con finitura differente dallo standard comporta una variazione del prezzo. *A choice of different component finishes will result in a price variation.*



supporto intermedio  
*intermediate bracket*



## SCelta Composizioni - CHOICE OF COMPONENTS

### Finiture disponibili - Available finish



alluminio satinato  
*satin finish*



alluminio lucido  
*polished finish*



laccato bianco opaco RAL 9003  
*matt white RAL 9003*

### Fondale - Hem bar



FQ20



FL20



FL20 standard



FL20 slim

### Varianti tappo fondale FL20 - Hem bar FL20 end caps optional

### Supplementi - Supplements

Prolunga per staffa - Bracket extension



satinato - bianco opaco  
*satin finish - matt white*

lucido - polished finish

Angolare per mantovana - Pelmet end cap finishing



satinato - bianco opaco  
*satin finish - matt white*

lucido - polished finish

### Supplementi - Supplements

■ motore con finecorsa elettronico  
*motor with electronic switch*

■ telecomando monocanale  
*remote control single channel*

■ motore con ricevente radio integrata  
*motor with incorporated receiver*

■ telecomando multicanale (5 canali + 1 generale)  
*remote control (5 channels + 1 general)*

## INGOMBRI - DIMENSIONS

### ATTACCO A PARETE - WALL MOUNTING

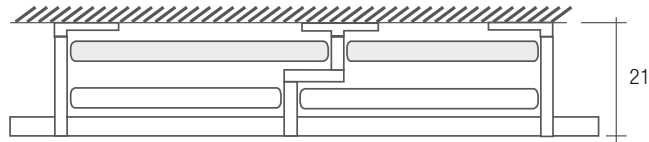
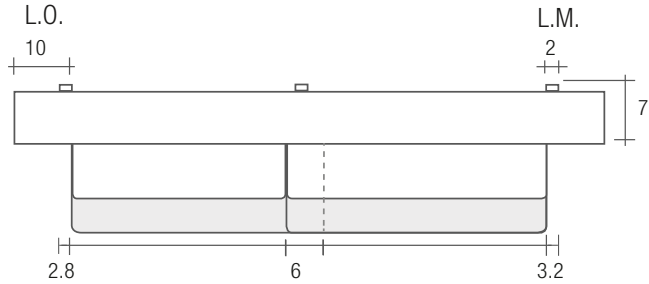

### supporti intermedi - intermediate brackets

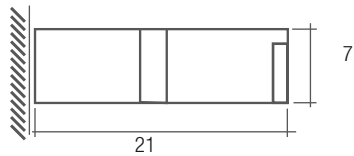

L.M. = lato motore - operation side L.O. = lato opposto - opposite side

### ATTACCO A SOFFITTO - CEILING MOUNTING

